



! READ BEFORE BEGINNING INSTALLATION & SET-UP !



Refer to the user's guide for safety instructions and supplemental information.



Do not remove the protection film during the mechanical adjustments. Remove it before launching a teach-in.

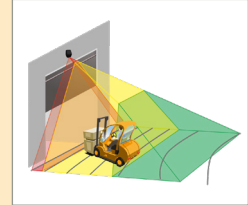

Following installation, always test for proper operation before leaving the premises.

1 OPENING THE SENSOR

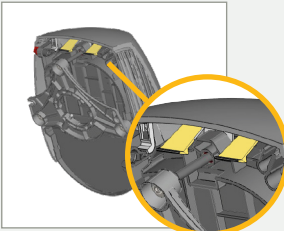

Make sure the cover is not locked (red cover lock). Pull the two legs on top in order to open the cover.

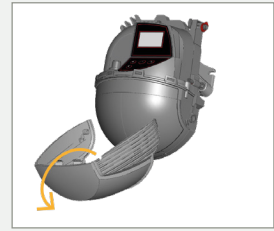
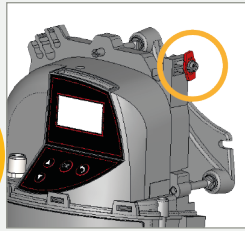

Completely remove the cover before installing the sensor.

2 ADJUST SETTINGS (IF NEEDED)



- a. Adjust the sensor before mounting for easier access to the LCD screen.
- b. Adjust the function and logic of the outputs only if required by your application.
- c. Open the USB cap and power the sensor using a mini USB charger or battery.

Adjustments may also be made after Teach-In, if not using the USB.

Ex:



Quick Start
In-Out
Motion

OUT 1



I/O Function
Motion or PC
Out1Logic
Out1Logic NO
Out2Function

Motion detection or presence detection in pull-cord zone

Normally open

OUT 2



Out2Logic
Out 2 Function Pres or Sfty
Out 2 Logic
Out2Logic NC
RelFunction

Presence detection of object in presence or safety field

Normally open

RELAY



Out 2 Logic
RelayFunction
HeightTrigger
RelayLogic
RelayLogic De-energized
>More

Detection of object if height > 7 ft 4 in

De-energized in no detection

3 MOUNTING & WIRING



Install the sensor in the left corner or the center of the door as high as possible (max. 19'6").

The size of the detection field depends on the mounting height.

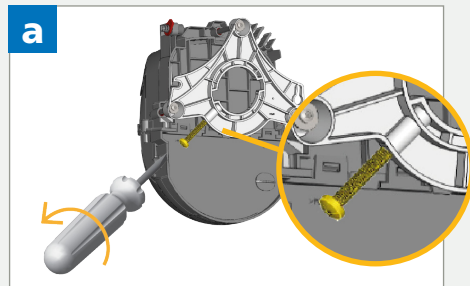
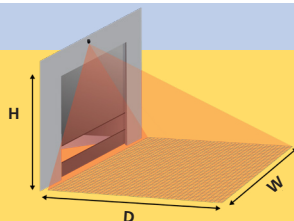

Verify if the angle lock screw is positioned as indicated. Unscrew if necessary.

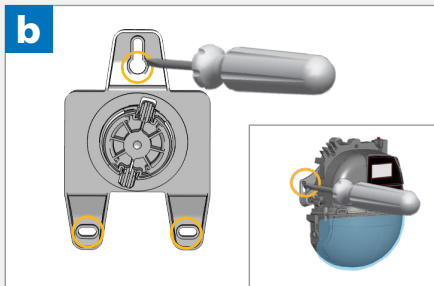

Remove the mounting bracket from the sensor and secure it to the wall. You can also install the sensor directly without using the mounting bracket.

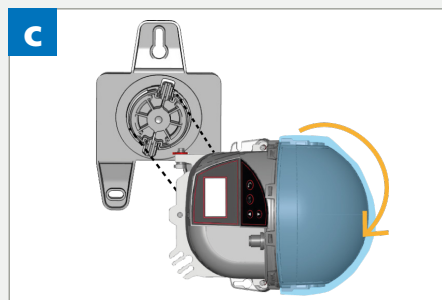

Position the sensor horizontally and secure the sensor to the mounting bracket.

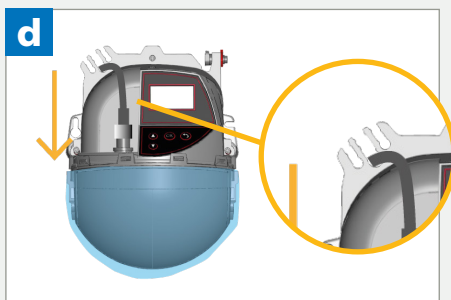

Plug in the connector and pass the cable through the cable passage without making a loop.

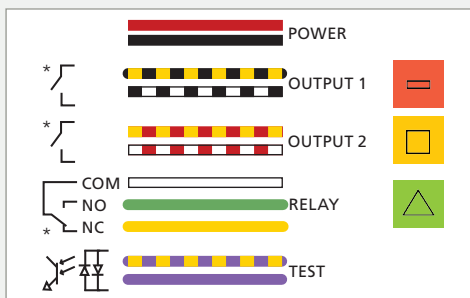

Connect the wires accordingly.

* output status powered during non-detection with factory values



Launch teach-in after angle adjustment.

All presence/safety outputs are activated.

4 ANGLE ADJUSTMENT



Power the sensor. The LCD screen shows the detection display.

Activate the 2 visible laser spots by double-clicking OK or using the remote control sequence shown to the right.

The visible laser beams stay activated for 15 minutes or can be turned off by double-clicking OK.

Do not look directly into the laser emitter or the visible red laser beams.



OR



Remove the blue protection film from the laser window.

PARALLEL ANGLE

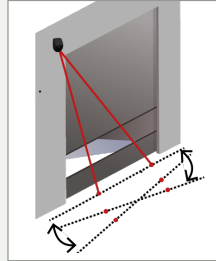
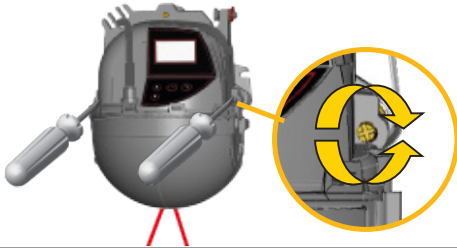

Make sure the curtain is parallel to the door by adjusting one or both screws on the side.

TILT ANGLE

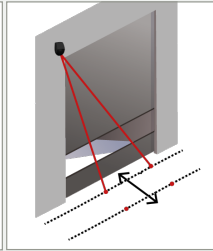

When the safety function is required, the red spots should be as close to the door as possible.

Negative angles reduce the depth of the detection fields.

Position the curtain closer to or farther away from the door by turning the screw at the top.

LATERAL ANGLE

Launch the POSITION WIZARD to position the detection field correctly in front of the door.

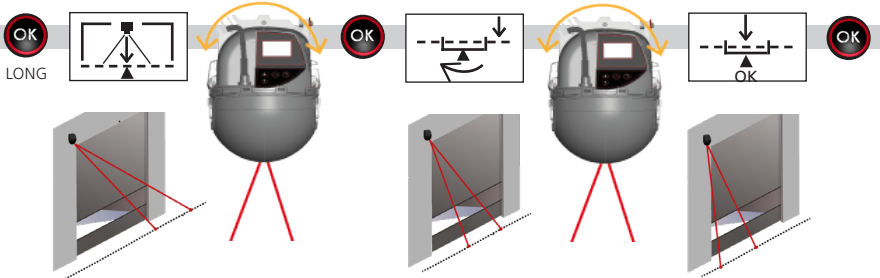

1. Push and hold OK to launch the POSITION WIZARD.
2. Rotate the sensor in order to align the center of the red spots with the center of the door. Push OK.
3. Rotate the sensor until the LCD screen validates the position. Push OK to exit.

The size of the detection field depends on the mounting height:

	DETECTION FIELD
6 ft	7.2 × 7.2 ft
9 ft	10.8 × 10.8 ft
12 ft	14.4 × 14.4 ft
15 ft	18 × 18 ft

Lock the sensor position by tightening the angle lock screw (see step 6A).

5 TEACH-IN: INSTALL

The teach-in zone (square in front of the 2 visible spots) should be completely free and flat.



This teach-in must be launched each time one of the sensor angles has been changed.

Make sure the protection film and cover are removed.

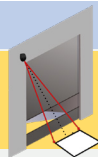

1. Launch a teach-in by LCD or remote control (Quick Start > Teach-in > Install).

LCD

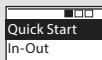

REMOTE CONTROL



2. Clear the teach-in zone in front of the sensor.

The learning process starts. Position, angle, and height are learned; the background is analyzed and the teach-in ends successfully. If this is not accomplished, refer to the TROUBLESHOOTING section in the user's guide (75.5916).

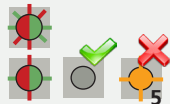

SETTINGS FOR 3 MAIN FUNCTIONS



MOTION

C WIDTH 000 – 999 Factory value: **240 in**

D DEPTH 000 – 999 Factory value: **287 in**



PRESENCE

C WIDTH 000 – 999 Factory value: **240 in**

D DEPTH 000 – 999 Factory value: **80 in**



SAFETY

C WIDTH 000 – 999 Factory value: **240 in**

D DEPTH 000 – 999 Factory value: **16 in**

6 CLOSING THE SENSOR

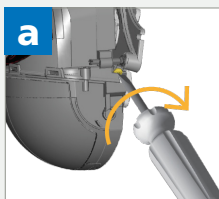

Lock the lateral angle by firmly fastening the angle lock screw.

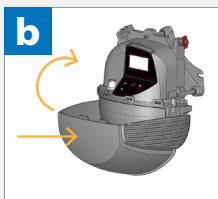

Reclip the sensor cover horizontally and close it as indicated.

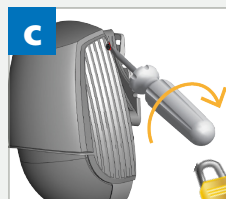

Lock the cover by turning the lock screw clockwise.

BEA INSTALLATION/SERVICE COMPLIANCE EXPECTATIONS

BEA, the sensor manufacturer, cannot be held responsible for incorrect installations or inappropriate adjustments of the sensor/device; therefore, BEA does not guarantee any use of the sensor outside of its intended purpose.

BEA strongly recommends that installation and service technicians be AAADM-certified for pedestrian doors, IDA-certified for doors/gates, and factory-trained for the type of door/gate system.

Installers and service personnel are responsible for executing a risk assessment following each installation/service performed, ensuring that the sensor system installation is compliant with local, national, and international regulations, codes, and standards.

Once installation or service work is complete, a safety inspection of the door/gate shall be performed per the door/gate manufacturer recommendations and/or per AAADM/ANSI/DASMA guidelines (where applicable) for best industry practices. Safety inspections must be performed during each service call – examples of these safety inspections can be found on an AAADM safety information label (e.g. ANSI/DASMA 102, ANSI/DASMA 107).

Verify that all appropriate industry signage and warning labels are in place.



Tech Support: 1-800-407-4545 | Customer Service: 1-800-523-2462
General Tech Questions: Tech_Services@beainc.com | Tech Docs: www.BEAinc.com

